

DETAILED SPECIFICATION FOR CRYSTAL PART # X20.000SC-43-M3-20AB

KEY FEATURES

- f 20.000 MHz
- COLD WELDED HC-43/U
- 3RD OVERTONE – HIGH Q VALUE
- SC CUT
- FOR OCXO APPLICATION

DESCRIPTION

Well documented / high performance Quartz Crystal with high Q value enabling low Phase Noise and low aging. For use in high performance and high reliability OCXO applications.

DETAILED SPECIFICATION ► ELECTRICAL

1. GENERAL

Item	Parameter	Condition	Value	Tolerance	Unit	Note
1.1	Angle of cut		SC			
1.2	Mode of operation	Overtone	3rd			
1.3	Circuit type	Series resonance				
1.4a	Circuit type	Parallell resonance				
1.4b	Load capacitance, C_L		20	+/- 1	pF	
1.5	Drive level, nom P	Nominal P	50	+/- 10 %	uW	
1.6	Drive level, max P	Maximum P		+/- 10 %	uW	
1.7	Package	HC-43/U				Height mm

2. TEMPERATURE CHARACTERISTICS

Item	Parameter	Condition	Min.	Typ.	Max.	Unit	Note
2.1	Reference temperature, ref T		+80	+88	+96	°C	
2.2	Operating temperature range					°C	
2.3	Storage temperature range		-55		+105	°C	

3. ELECTRICAL PARAMETERS

3.1	Motional resistance	R_1	45	60	75	Ohm	
3.2	Motional inductance	L_1		300		mH	
3.2	Motional capacitance	C_1	0.17	0.21	0.25	fF	
3.3	Static shunt capacitance	C_0	3.2	3.6	4.0	pF	
3.4	Figure of merit	Q	550 000	640 000	700 000	-	
3.5	Shunt inductance	L_0		18		µH	Optional C_0 cancellation

4. FREQUENCY CHARACTERISTICS

4.1	Nominal frequency	@ ref T, C_L and nom P		20.000 000		MHz	
4.2	Frequency accuracy	@ ref T, C_L and nom P	-2.0		+2.0	ppm	
4.3	Drive level dependency, $R_1(P)$	R_1 max / R_1 min			10	%	DLD sweep from 0.1 uW – nom P
4.4	Drive level dependency, $f_1(P)$	$\Delta f / f$ nom				ppm	DLD Sweep from 0.1uW – nom P
4.5	Long term stability (aging)	First year	-15		+15	ppb	After 30 days of continues operation
4.6	Long term stability (aging)	After first year				ppb	After 30 days of continues operation

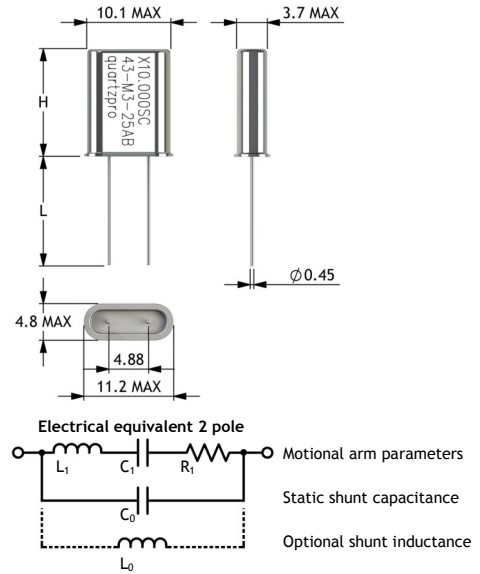

DETAILED SPECIFICATION FOR CRYSTAL PART # X20.000SC-43-M3-20AB

DETAILED SPECIFICATION ► ENVIRONMENTAL

5. VIBRATION IEC 60068-2-6 Fc (Sinewave)

Item	Description	Parameter	Condition	Units	Notes
5.1	Frequency range	10 - 55 Hz	Amplitude, 0.75	mm	
5.2	Frequency range	55 - 500 Hz	Acceleration, 10	g	
5.3	Sweep rate and direction	1 octave / minute	up / down = 11	min	5.5 octaves - 5.5 min / sweep*2 (1 up/1down)
5.4	Direction and number of sweeps	X, Y and Z	10 sweeps		
5.5	Duration	5.5 min x 2 sweep x 10 sweep	5.5 x 2 x 10 = 110	min	~ 1 hour 50 min

6. SHOCK IEC 60068-2-27 Ea

6.1	Pulse waveform	Half sine	40 (peak)	g	
6.2	Pulse length		11	ms	
6.3	Sign, direction and number of shocks	+/- X, Y and Z	5		In each direction, totally 5*6=30

7. TEMPERATURE CYCLING IEC 60068-2-14 Na

7.1	Low temperature		-40	Deg C	
7.2	High temperature		+85	Deg C	
7.3	Transition time		2 - 3	min	
7.4	Exposure time	Time in each temperature	10	min	
7.5	Number of cycles		5		

8. ADDITIONAL INFORMATION

8.1	Wire cutting	Use a low shock wire cutter
8.2	Wire bending	Before bending of wires apply a flat plier at least 2 mm from glass insulation feedthrough and press so that the wire is strain relieved
8.3	Soldering	Use flux and a tip temperature of not more than 350 deg C and apply to crystal lead terminal for max 5 seconds.
8.4	Cleaning	If No Clean solder is used –not necessary to clean but recommended when flux is used.
8.5	ESD	Use normal ESD precautions.
8.6	Hermeticity	< 1·10 ⁻⁸ mbar liter / sec

DETAILED SPECIFICATION FOR CRYSTAL PART # X20.000SC-43-M3-20AB

EXAMPLE OF PRODUCT PART NUMBER DESIGNATION AND INTERPRETATION.

Item	Product Category	1. Frequency	2. Angle of cut	3. Package	4. Mode of operation	5. Circuit type	6. Version
Parameter	X	10.000 MHz	SC	HC-43/U	3rd Overtone	Load Capacitance, 25pF	
Code	X	10.000	SC	- 43	- M3	- 25	AB

Part number designation : X10.000SC-43-M3-25AB

DETAILED SPECIFICATION ► MECHANICAL

9. LABEL MARKING

Line 1, Product Category, Frequency, Cut	in MHz - Cut Ex. X10.000SC
Line 2, Part number	Package - Mode - Circuit, Version Ex. 43 - M3 - 25AB
Other information on request.	

10. MECHANICAL DIMENSIONS

	(mm)
H = Height	13.3 MAX
L = Pin length	13.2 ±0.5

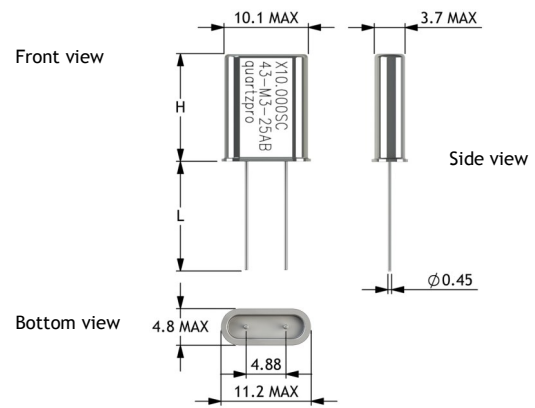

11. REVISION HISTORY

Date	Description
11.1 2009.02.06	First issue
11.2 2014.08.15	New detailed datasheet
11.3	
11.4	
11.5	
11.6	

UNLESS OTHERWISE SPECIFIED:
DIMENSIONS ARE IN MILLIMETERS

TITLE X-HC43U

NAME	SIGN.	DATE	TOLERANCES	DWG NO.	X-HC43U
DRAWN	Vikram Singh	VS	2009.02.02	MATERIAL A	REV. 0.1
CHK'D	Anders Aven	AA	2009.02.03	MATERIAL B	
APPV'D	Anders Olsen	AO	2009.02.03	WEIGHT GR	
NOTE					

SHEET 1 OF 1